

FILL IN SHADED AREAS TO COMPLETE THE PART DESCRIPTION

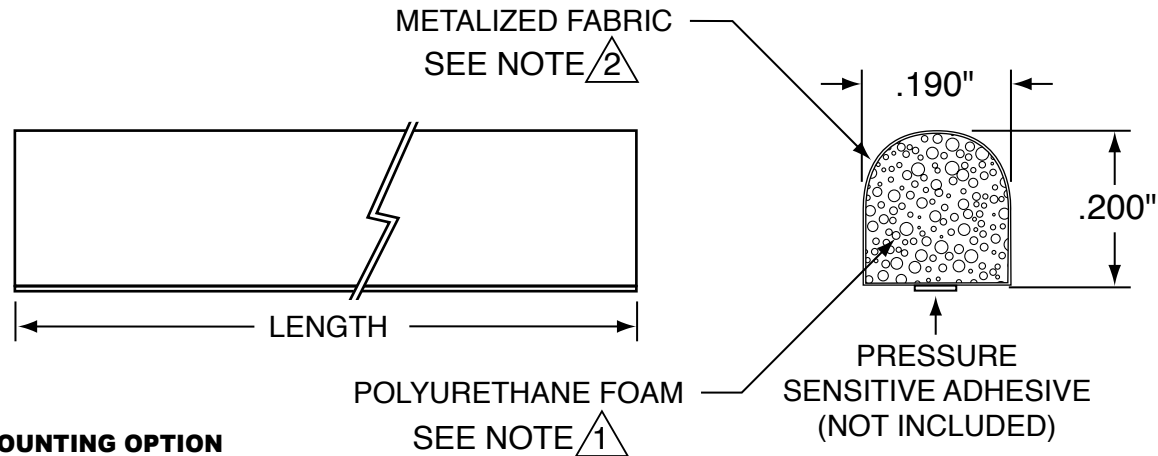

SELECT ADHESIVE MOUNTING OPTION

- WITH PRESSURE SENSITIVE ADHESIVE.
- WITHOUT PRESSURE SENSITIVE ADHESIVE.

FILL IN LENGTH IN INCHES BELOW

Fill in length to two decimals (LL.LL). Maximum 84.00 inches.
 Non-essential leading zeros will be eliminated on the length.

TECH-ETCH MANUFACTURING PART NUMBER

2431 - 101 - 0154 -
 (PROFILE) - (LENGTH)

NOTES:

- 1 OPEN-CELLED POLYURETHANE FOAM CORE.
- 2 NICKEL PLATING OVER COPPER SUBSTRATE FABRIC.
- 3. COMPRESSION SET (ASTM D3574) 2.6%.
- 4. FLAMMABILITY RATING UL 94 V-RATED.
- 5. COMPRESSION DEFLECTION (ASTM D3574) 1.47 PSI.
- 6. SURFACE RESISTIVITY (ASTM F390) <.02 OHMS.
- 7. SERVICE TEMPERATURE -40°F TO 194°F (-40°C TO 90°C).
- 8. UNLESS OTHERWISE SPECIFIED DIMENSIONS ARE IN INCHES.

UNLESS OTHERWISE SPECIFIED ALL TOLERANCES TO BE:
 HEIGHT & WIDTH
 <.100 ±.02
 >.100 ±.03
 LENGTH
 1 TO 6 ±.03
 6 TO 11 ±.05
 11 TO 24 ±.15
 24+ +1/-.25

Tech-Etch

45 Aldrin Road, Plymouth, MA 02360
 TEL 508-747-0300 • FAX 508-746-9639
 sales@tech-etch.com • www.tech-etch.com

SCALE:

400%

CATALOG PROFILE:

2431 - 101 - 0154

DATE:

1/15/18

PART NAME:

D Metalized Fabric Gasket

CUSTOMER PART NUMBER: